



**Witzel**

**Vacupress**

**WITZEL VACUPRESS e.K.**

Inh. Hendrik Witzel

Max-Keith-Str. 66 - D-45136 Essen

☎ +49 201 6462284 📠 +49 201 6462852

✉ info@vacupress.de 🌐 www.vacupress.de

# **Infrared-Oven IR2102 DUAL**

*(Translation of Original-)*

- 1. Setup + assembling**
- 2. Manual instruction**

Before the first commissioning of the unit  
**read important safety instructions on page 15!**

**This manual is an integral part of the installation and must be handed over to a new owner in case of sale or to an operator in case of use by a third party.**



<b>INDEX</b>	<b>TABLE OF CONTENTS</b>	<b>PAGE</b>
<b>A)</b>	<b>INTRODUCTION</b>	
<b>A1)</b>	<b>General information</b>	<b>5</b>
<b>A2)</b>	<b>Manufacturer data</b>	<b>5</b>
<b>A3)</b>	<b>References</b>	<b>5</b>
<b>A4)</b>	<b>Type plate</b>	<b>6</b>
<b>B)</b>	<b>SAFETY</b>	
<b>B1)</b>	<b>General safety instructions</b>	<b>7</b>
<b>B2)</b>	<b>Residual risk</b>	<b>7</b>
<b>B3)</b>	<b>Pictograms</b>	<b>9</b>
<b>B4)</b>	<b>Personal protective equipment</b>	<b>9</b>
<b><u>PART 1:</u></b>		
<b>1.</b>	<b>Setup + Assembling instructions</b>	<b>10</b>
<b>1.1.</b>	<b>Introduction + part list</b>	<b>10</b>
<b>1.2.</b>	<b>Assembly</b>	<b>11</b>
<b><u>PART 2:</u></b>		
<b>2.</b>	<b>Manual instructions</b>	<b>14</b>
	<b>Purpose of the IR2102 DUAL</b>	<b>14</b>
<b>2.1.</b>	<b>Attention</b>	<b>15</b>
<b>2.2.</b>	<b>Operation instructions</b>	<b>16</b>
<b>2.2.1.</b>	<b>The Infrared-Oven (case)</b>	<b>16</b>
<b>2.2.2.</b>	<b>The Roll about-Tray</b>	<b>17</b>
<b>2.3.</b>	<b>Features of the controller (Touch panel)</b>	<b>22</b>
<b>2.3.1</b>	<b>Setup- and Information screens</b>	<b>23</b>
<b>2.3.2</b>	<b>Oven operation</b>	<b>31</b>
<b>2.3.3.</b>	<b>Error- and Alert-Messages</b>	<b>33</b>
<b>3.</b>	<b>Application of the IR3202 DUAL</b>	<b>34</b>
<b>3.1.</b>	<b>General notes</b>	<b>34</b>
<b>3.2.</b>	<b>Heating of flat plastics directly on the Tray</b>	<b>34</b>
<b>3.3.</b>	<b>Heating of plastics with Blister-Forming frames</b>	<b>35</b>
<b>3.4.</b>	<b>Specials</b>	<b>37</b>

<b>INDEX</b>	<b>TABLE OF CONTENTS</b>	<b>PAGE</b>
<b>4.</b>	<b>Care and maintenance</b>	<b>38</b>
<b>4.1.</b>	<b>Oven-housing</b>	<b>38</b>
<b>4.2.</b>	<b>Front-door</b>	<b>38</b>
<b>4.3.</b>	<b>Quartz-Infrared-Tubes</b>	<b>38</b>
<b>4.4.</b>	<b>IR-optical measuring-unit</b>	<b>39</b>
<b>4.5.</b>	<b>Illumination</b>	<b>40</b>
<b>4.6.</b>	<b>Roll about-Tray</b>	<b>40</b>
<b>4.7.</b>	<b>Teflon-coating</b>	<b>40</b>
<b>4.8.</b>	<b>Breaker / Fuse</b>	<b>42</b>
<b>4.9.</b>	<b>Error messages and Rectification of defects</b>	<b>43</b>
<b>5.</b>	<b>Circuit diagram</b>	<b>46</b>
<b>6.</b>	<b>Spare parts</b>	<b>47</b>
<b>7.</b>	<b>Technical Details</b>	<b>48</b>
<b>8.</b>	<b>Declaration of conformity</b>	<b>49</b>

## A) INTRODUCTION

### A1) GENERAL INFORMATION

These instructions are intended to provide the user and all authorised persons with important information about the safe use and maintenance of the IR2102 DUAL infrared oven. The instructions are a key part of the IR2102 DUAL infrared oven and must be properly stored for the entire lifetime of the equipment. In case of disposal, leasing or cession of the right to use the IR2102 DUAL infrared oven, the instructions must be transferred to the new user along with the EC declaration of conformity. Any intervention in the equipment is prohibited unless all instructions in this manual have first been read attentively and properly understood. The illustrations in this manual merely constitute examples and are not binding for the manufacturer. The manufacturer reserves the right to make changes to components and parts for the purpose of improvement or other reasons, without updating this manual, provided this does not alter the operation and safety of the IR2102 DUAL infrared oven.

### A2) MANUFACTURER DATA

*Witzel VACUPRESS e.K.  
Max-Keith-Str. 66  
45136 Essen  
Phone +49 201 6462-284  
Fax +49 201 6462-852*

Please have the following information ready before contacting the manufacturer about the IR2102 DUAL infrared oven:

- Model and serial number of the oven
- Year of manufacture
- Purchase date
- Detailed information about the problem

### A3) REFERENCES

For better understanding of the information provided in this manual, information and instructions about situations considered critical or dangerous are highlighted using the following symbols:



#### **DANGER**

Identifies instructions that can lead to hazardous situations for personnel if they are not observed.



#### **ATTENTION**

Identifies instructions that can cause damage to the oven if they are not observed.

### A4) TYPE PLATE

Every IR2102 DUAL infrared oven has a type plate with the name of the manufacturer, the address, CE marking and the technical specifications.

The type plate is found on the rear of the control unit housing next to the power cable.

## B) SAFETY

### B1) GENERAL SAFETY INSTRUCTIONS

Reading these instructions before performing any work on the IR2102 DUAL infrared oven is important. Regardless of the information in these instructions, compliance with the safety regulations of the country where the oven is installed is mandatory. The requirements for the deployment of qualified personnel for various maintenance, operating and installation tasks must be observed.

The most important rules of conduct for the safe operation of the equipment are:

- Installation, operating and maintenance work always has to be carried out by qualified and trained personnel.
- Proper personal protective equipment always has to be worn, with no exceptions.
- All cleaning, adjustment and maintenance tasks may only be carried out after ensuring that the power supply has been disconnected.
- Never aim a jet of water at electrical components, even if they are protected by a housing.
- Never smoke during operation or maintenance, especially if solvents or flammable materials are used.
- Do not damage information signs or pictograms posted on the oven. If they should be damaged accidentally, install identical replacements immediately.

Witzel VACUPRESS assumes no liability for damage to property or personal injury resulting from the improper use of the oven, damage to its safety devices or failure to properly observe occupational safety regulations.

### B2) RESIDUAL RISK



#### **DANGER**

IR2102 DUAL infrared oven was developed so that the residual risk for the user and other personnel is reduced to a minimum. Exercise extreme caution and be very attentive when performing maintenance work. Familiarity after working with the oven frequently can often cause possible hazards to be forgotten or underestimated.

- **Danger due to high temperatures**  
The surface temperature on parts of the oven may exceed 70°C. Install the oven in a protected area which is only accessible to authorised personnel. Prior to any intervention, allow the oven to cool and/or wear corresponding personal protective equipment (heat protection gloves).
- **Danger due to underpressure**  
Avoid contact with the intake ports when operating the oven with the vacuum source connected. Ventilate the intake circuit prior to any intervention in the system. Contacting areas with underpressure may represent a source of accidents.
- **Risk of electric shock**

There are live components in the electrical system of the IR2102 DUAL infrared oven, which can result in severe personal injury and damage to property in case of contact. Any intervention in the electrical system must be carried out exclusively by qualified personnel.

- **Fire hazard**

Using the IR2102 DUAL infrared oven for purposes that are not intended or are prohibited by these instructions, and lack of or improper maintenance, may result in malfunctions associated with a risk of overheating and fire. Do not use water as an extinguishing agent in case of fire. Only use powder or CO2 fire extinguishers or other extinguishing agents suitable for electrical systems.



### B3) PICTOGRAMS

Pictograms with warnings and safety symbols for the user are installed on the IR2102 DUAL infrared oven. The symbols and their meaning must be read carefully and observed prior to using the oven.



#### **RISK OF ELECTRIC SHOCK**

**Proximity to (protected) electrical connections; accidental contact may result in electric shock or death.**



#### **DANGER HOT SURFACES**

**Proximity to surfaces with a temperature in excess of 70°C, which may lead to moderately severe burns.**



#### **DANGER HOT MATERIALS**

**Proximity to hot materials or surfaces with a temperature of more than 70°C. Always wear heat protection gloves to prevent burns.**

Witzel VACUPRESS accepts no liability for personal injury or damage to property due to failure to observe rules and regulations indicated by the pictograms, or if the pictograms are not in proper condition.

### B4) PERSONAL PROTECTIVE EQUIPMENT

These operating instructions are based on the assumption that the IR2102 DUAL infrared oven is installed in a place of work where all mandatory safety regulations are observed; in particular, the personnel must wear suitable personal protective equipment during all activities.

## **Part 1.**

# **Setup- and Assembling instructions Infrared-Oven IR2102 DUAL**

### **1.1. Introduction + part list**

The Infrared-oven IR2102 DUAL is purpose-designed for the O&P field to heat flat thermoplastic materials directly on the Roll about-Tray or by use of a bubble-forming frame. The IR2102 DUAL is delivered disassembled and can be installed at any place, in spite of its dimensions. Open the carrier box and check the integrity of all parts by the following part list.

1. 1 pc. Infrared-Oven housing  
B 2500 / T 1180 / H 700 mm 358 Kg
2. 4 pc. Legs for oven housing including bars  
(including 8 screws + washers M8 x 12 and 6 screws + washers M8 x 20)  
35 x 35 x 700 mm 10 Kg
3. 1 pc. Roll about Tray  
B 2190 / T 1060 / H 840 mm 75 kg
4. 4 pc. Legs for Roll about Tray with casters  
(including 8 screws + washers M6 x 20)  
25 x 25 x 150 mm 5 Kg
5. Tools:
  - 1 Allen wrench 4mm
  - 1 Allen wrench 6mm
  - 1 Allen wrench 8mm
  - 1 Open wrench SW10/13

## 1.2. Assembly

The assembly has to be done on a flat ground.

- 1.2.1. After removing the top and the four sides of the box first disassemble the legs of the oven which are mounted on the pallet for the transport. (pic. 1a). Now take the Roll about Tray with two persons carefully out of the oven (Abb. 1b + 1c). Put the housing of the Infrared-Oven on its backside (as delivered) at the place where it shall be assembled (Abb. 1c). If possible, for this the housing can remain on the base of the pallet.

**ATTENTION! Always lift the oven just at the housing itself and NEVER LIFT it at the switch-box or the door! NEVER remove the transport lockings of the door before the oven is setup correctly!**

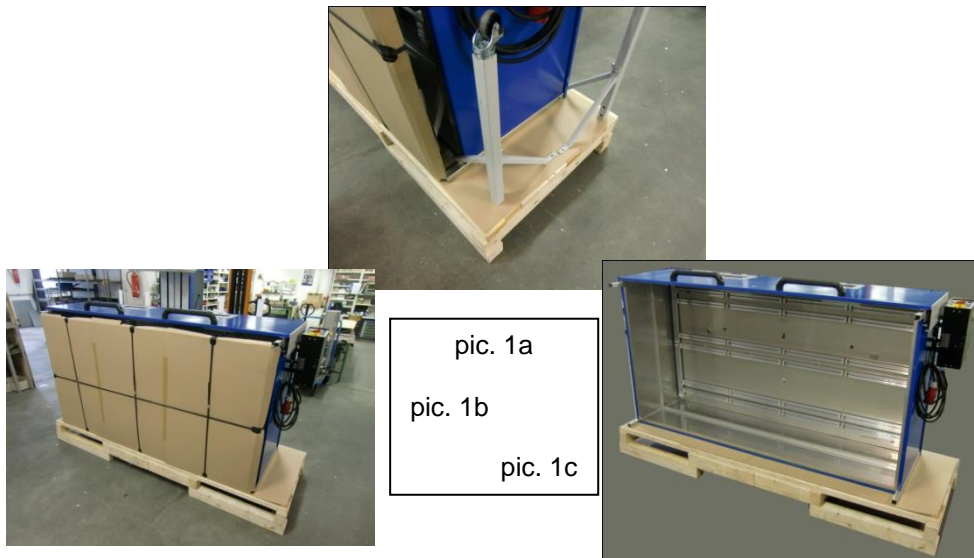

- 1.2.2. First assemble the front legs (the ones with only one strut) on the square tubes of the oven housing. Push each leg up to the end stop on the tube and fasten the 4 screws M8 x 12 with the enclosed wrench. Now fix the bars of the front legs at the housing using the screws M8 x 20 and tighten them well (pic. 2+3).

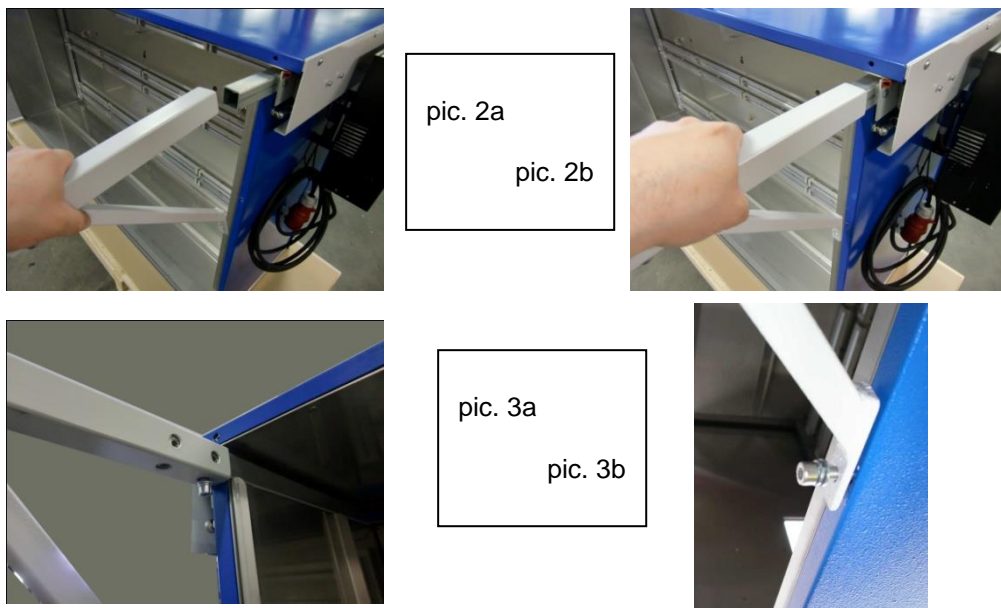

1.2.3. When all fixing screws of the front legs are tightened (especially the bars!!), you can tilt the oven-housing 45° to the front by help of 3-4 persons. Now it stands on the casters of the front legs and the square tubes of the rear side (pic. 4). Activate the stop of the front casters!

**ATTENTION! Always lift the oven just at the housing itself and NEVER LIFT it at the switch-box or the door! NEVER remove the transport lockings of the door before the oven is setup correctly!**

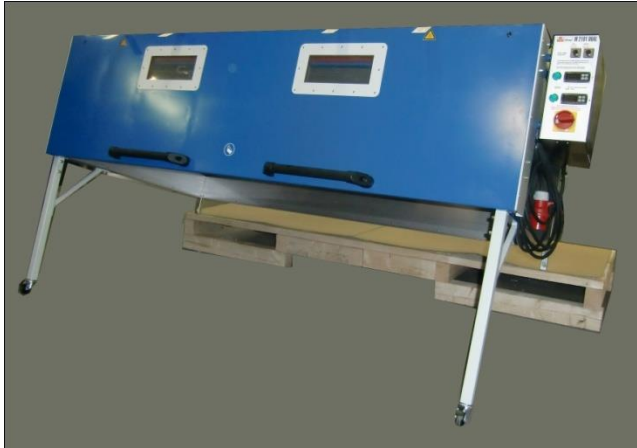

pic. 4

1.2.4. **To mount the rear legs now 5 persons are required!** Lift the oven by help of 4 persons at its backside and slide the two rear legs on to the tubes of the oven housing (pic. 5a + 5b). **As soon as the legs are slided on to the tubes you can sink the oven carefully. The end stop can be loaded directly, so the fixing screws can be fixed calmly when the oven is put down (pic. 5c).** Now fix the four bars with the enclosed allen screws (M8x20) to the housing first. After this you can tighten the four screws (M8x12) at each leg.

The assembly of the oven-housing is finished.



pic. 5a



pic. 5b



pic. 5c->

1.2.5. Finally you can remove the two transport locking devices on top of the oven housing. For this push down the Front door until it locks at the end position. Now the upper edge of the door should not contact the transport locking devices any longer. Now loosen the screws on top of the locking devices (pic. 6). Remove the transport locking devices and mount the screws at the oven lid again. Keep the transport locking devices for future transportations. Alternative you can remove only the white notes and fix the transport locking devices again while turning them 90° to the side. In this way you avoid to loose them. (pic. 7)



pic. 6  
pic. 7



1.2.6 Next the four casters of the Roll about–Tray have to be mounted with the enclosed Allen screws (M6x20). When the assembly of the casters is finished, you can set the Roll about-Tray upright and remove the transport protection of the tray.



pic. 8a  
pic. 8b

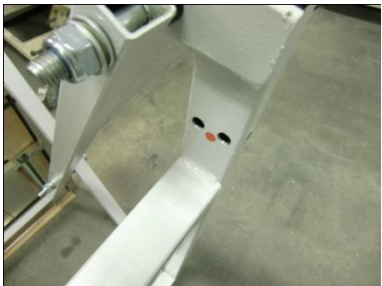

pic. 8c  
pic. 8d



## **Part 2.**

# **Manual instructions - Infrared-Oven IR2102 DUAL**

### **Purpose of the IR2102 DUAL**

The use of the IR2102 DUAL Infrared-Oven is restricted to the following purposes:

1. Heating of thermoplastic materials directly on the Roll about Tray
2. Heating of thermoplastic materials which are clamped into an extra Blister-Forming frame which can be put on a cradle (option, Article 07-134).

**All other applications are not allowed!**

**IT IS NOT ALLOWED TO USE MATERIALS WHICH CONTAIN SOLVENTS OR OTHER  
INFLAMMABLE SUBSTANCES!**



**ATTENTION! DANGER OF SPONTANEOUS IGNITION OR DETONATION OF SOLVENT  
CONTAINING GAS!**

## 2.1. ATTENTION



### ATTENTION

Verify that the mains voltage and frequency match the values specified on the type plate.

2.1.1 The electrical connection provided should be checked by an expert to verify that the wiring conforms to the standards.

***Incorrect assignment of the n-terminal device can result in the immediate destruction of components!***

2.1.2 Correct wiring is not assured, even if other machines have operated properly using the connection provided.



### DANGER

Work on electrical equipment and components may only be completed by trained, qualified personnel or licensed electricians!

In case anything is unclear, our technical customer service can be contacted.

*Witzel VACUPRESS e.K.  
Max Keith Str. 66  
D-45136 Essen - Germany  
Phone +49/201/6462-284  
Fax +49/201/6462-852  
E-mail: info@vacupress.de*

## 2.2. Operation instructions

Before you start to work please have a look on the components and actuators of your IR2102 DUAL as shown and described below. Essentially the IR2102 DUAL consists of two components, the oven housing with the electronic equipment and the Roll about Tray.

### 2.2.1 The Infrared-Oven (housing) (pic. 9)

The housing of the oven includes beside the electronic devices the quartz-infrared tubes (heating) and the optical temperature measuring unit.

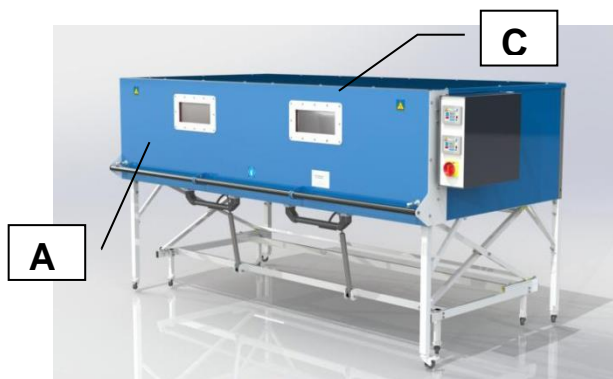

pic. 9

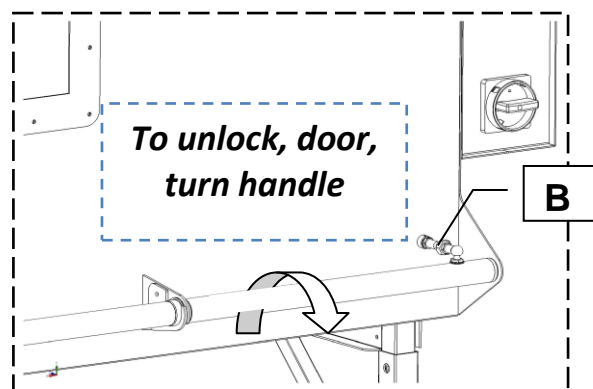

pic. 9a

#### 2.2.1.1 FRONT-DOOR – pic. 9

The door (A) of the IR2102 DUAL is designed as a vertical sliding door, which helps to save a lot of space while opening and closing the door. It is guided by two side-mounted ball-bearing telescope bars and lifted by two gas springs. The door is locked at the lower end position by two adjustable notches (B). To unlock the door, turn handle.

NOTE: As soon as the oven door is opened, the IR-tubes are deactivated to save energy.

#### 2.2.1.2 DOUBLE PANE VIEWING WINDOW – pic. 9

The two double pane viewing windows (C) are integrated into the Front door and allow to control the heating process while the door is closed.

#### 2.2.1.3 FAN FOR THE OPTICAL SENSOR – pic. 9

Two fans cool the optical sensors, they are integrated on top of the oven. The fans are running all the time while oven is switched on by the ON-OFF main switch.

**ATTENTION! NEVER COVER THE FANS BECAUSE ITS FUNCTION IS AFFECTED AND THE OPTICAL IR-SENSORS CAN BE OVERHEATED BY THIS.**



#### 2.2.1.4 INFRARED-QUARTZ-TUBES (HEATING ELEMENTS) – pic. 10 (A)

The oven is equipped with 28 Infrared heating elements. The Quartz-tubes are each fitted with reflectors and can be replaced single when needed. The Heating (area) is split into a left and aright Zone. The two Zones can be controlled individually and independant by use of the DUAL control elements. This allows to heat either an area of 2 x 1 meter or two areas of 1 x 1 meter.



Abb. 10

#### 2.2.1.4.1 SEPARATING WALL – pic.10 (D)

The oven is equipped with a removeable separating wall. It allows to use the two zones with different temperatures at the same time. If necessary, the wall can be disassembled (push up and pull to the front)

#### 2.2.1.5 OPTICAL TEMPERATURE-SENSOR – pic. 10 (B)

The IR2102 DUAL is equipped with two optical Temperature-Sensors (IR-sensor) which operate independent. The sensors are placed on top in the middle of the heating area between the tubes of the left and right zone. The IR-sensors look on the material from the top and measure the surface temperature of the material placed in the respective measuring area.

#### 2.2.1.6 ILLUMINATION – pic. 10 (C)

The IR 1301 has four 25W bulbs for illumination. The bulbs are automatically activated when the oven is turned ON and OFF by the main switch.

### 2.2.1.7 MAIN SWITCH – pic. 11 (A)

The oven is turned ON and OFF by use of the main switch (A). As soon as the oven is turned ON the two controller (Touch-panel), the illumination and the fans of the optical sensors are running.



pic. 11

### 2.2.1.8 CONTROLLER (Touch-panel) – pic. 11

The controller are the central units of the oven. They are equipped with a microprocessor controller and a touch sensitive panel for user in- and output. Where the upper controller (B1) is handling the operation of the left heating zone and the lower controller (B2) is handling the operation of the right heating zone. Thus both heating zones can be operated completely independent.

### 2.2.1.9 EXTERNAL USB PORT – pic. 11 (not visible)

The software of the controller can be updated by an USB port at the backside of the switch box. The update is applied by a USB stick. The update shall only be applied under instruction of our service personnel. In any way no other USB devices may be connected to this port. ATTENTION! Misuse can cause irreversible damage of the installed soft- and/or hardware.

#### **2.2.1.10 Safety-Thermostat**

In case of a malfunction of the Temperature control elements, the IR2102 DUAL is equipped with a safety-thermostat (STB) which turns off the oven when overheated. In that case the oven is shut down completely. The STB is located at the backside of the black switch-box. After the STB has tripped, turn off the main-switch (A) and let the oven cool down. After the oven has cooled down, you can reset the STB by pushing the red button until you hear it locking. Should the STB trip again, please contact our technical service.

## 2.2.2. The Roll about tray

The second main unit of the IR2102 DUAL is the Roll about tray. The Roll about tray can be removed from the oven housing on its 4 casters when the front door is opened. Thus you can easily place the material onto the tray, heat it up and afterwards bring it to work workplace without carrying the hot plastic across your workshop. Further the tray is continuously height adjustable. **At the upper position flat materials can be placed on the tray directly. The lower position is used for bubble-forming frames** (with legs placed directly onto the tray or by use of a cradle (option Article 07-134)). **ATTENTION! The Roll about tray is designed for a maximum load of 40kg. Never overload the Roll about tray!**

### 2.2.2.1 The tray - pic. 13 (A)

The tray consists of a heat resistant top layer, a middle layer of insulator and a aluminum base. At the upper layer (below the Teflon fabric) in the middle of each Zone is a marking for the optical sensor (measuring area). The tray is covered with a robust nonstick Teflon fabric. The tray is inserted loose into the upper frame of the carriage and can be lifted easily when necessary.

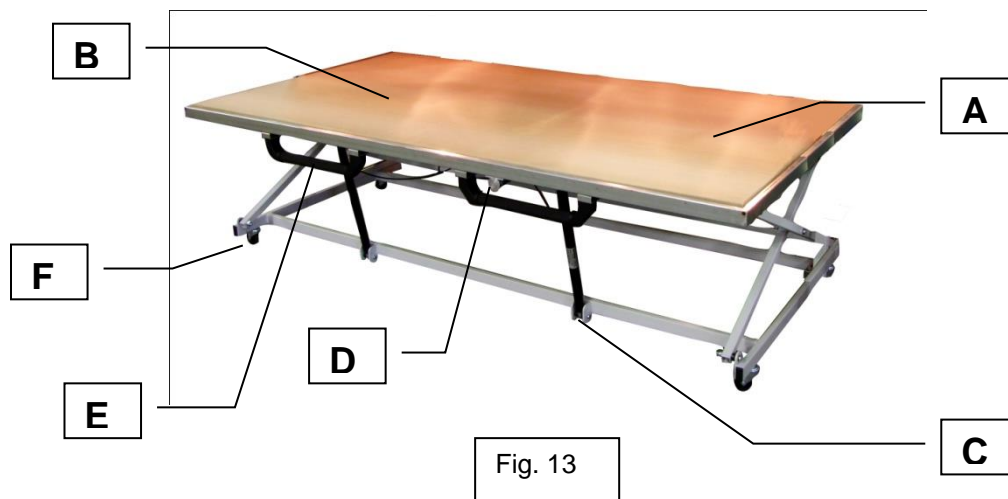

### 2.2.2.2 The Teflon fabric – pic. 13 (B)

The Teflon fabric prevents materials from sticking to the tray. It consists of a robust glass-fibre fabric and can be replaced easily when necessary. To guarantee a lifetime as long as possible it is recommended that it is not scratched or damaged by sharp items.

### 2.2.2.3 The gas-shocks (Height adjustment) – pic. 13 (C)

The integrated gas-shocks allow a one-hand height-adjustment of the tray. The gas-shocks are self-locking and keep the tray in every wanted position. To adjust push the button (D) and hold it. After adjusting the height by pulling up or pushing down the tray with the handle (E), simply release the button (D). The gas-shocks now automatically lock again at the new position. **ATTENTION! The Roll about tray is designed for a maximum load of 40kg. Never overload the Roll about tray!**

### 2.2.2.4 The locking casters – pic. 13 (F)

The Roll about tray is equipped with lockable casters. To avoid the tray from rolling you should lock the casters when you lift larger heated pieces of material.

### 2.2.2.5 Marking for the optical sensor – pic. 14

The IR2102 DUAL is equipped with two optical temperature sensors. On for each Zone, left and right. These sensors „look“ on a central area of the tray in the respective zone. When you put smaller pieces of material into the oven you have to ensure that they are placed right in this measuring area. To make this easier there is a marking on the tray in the middle of each zone which shows the measuring area (Roll about tray completely slid into the oven). As the tray is height adjustable the measuring areas varies. The inner circle (A) shows the measuring area with the tray in the upper position. The outer circle (B) shows the measuring area with the tray in the lower position.



pic. 14

## 2.3. Feature of the controller (Touch-panel)

The IR2102 is equipped with a programmable control (SPS) which is capable to integrate multiple features. The user in- and output is realized by a touch sensitive 3,5" TFT screen which can be handled intuitively by finger or stylus input. The different screens are explained below. NOTE: The operation of the controller for the left and for the right heating zone is similar.

### 2.3.1. Setup- and information-screens

#### 2.3.1.1. Start

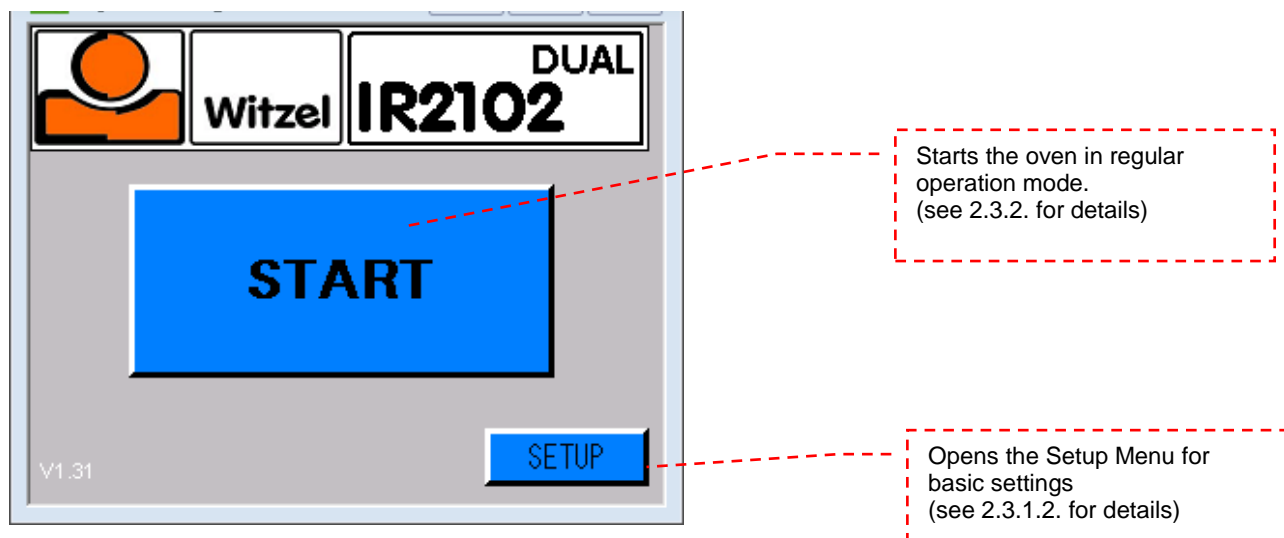

After turning on the oven the controller runs a self-test. After a few seconds the above start screen is displayed.

To start running the oven in operation mode push „START“ (for further details refer 2.3.2). By use of the „Setup“ button the submenu for basic settings is entered(see 2.3.1.2. for details).

### 2.3.1.2. Setup

The Setup screen consists the buttons for switching the different menu languages as well as the buttons for further configuration options.

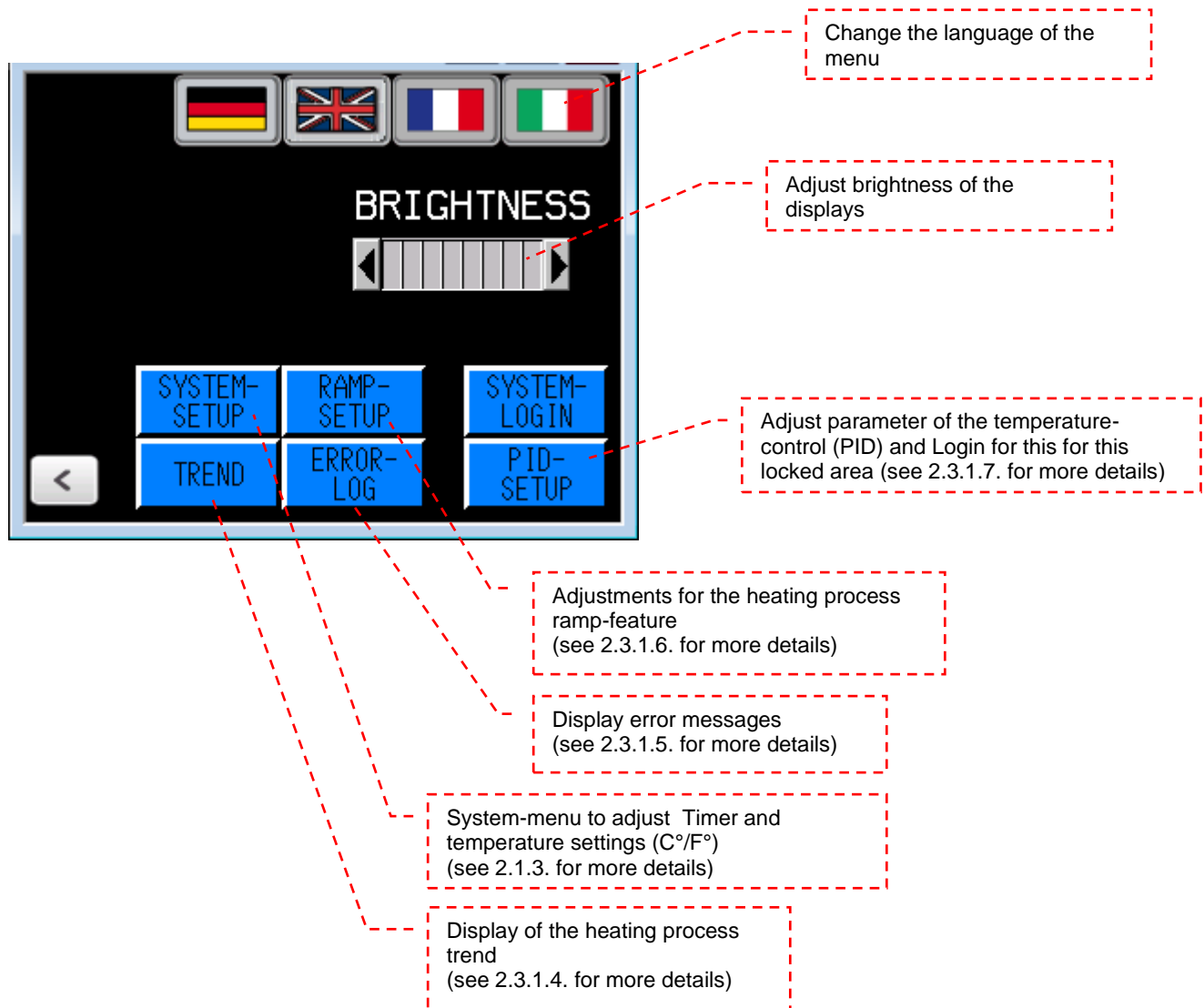

### 2.3.1.3. System-Setup

The system setup screen consists the timer setup to preset the time in hours and minutes further the temperature setting can be selected between °C and °F. ATTENTION! Switching the temperature setting will NOT convert the numbers in all operation modes as well as the heating ramp setup. These numbers must be adjusted manually after the temperature setting has been switched between °C and °F!

At the bottom of the screen the current system time is displayed. The feature "TIME SETUP" opens a screen where the system time and date can be adjusted.

At the upper right corner the serial number of the oven is displayed. The serial number is required at maintenance requests or spare part orders.

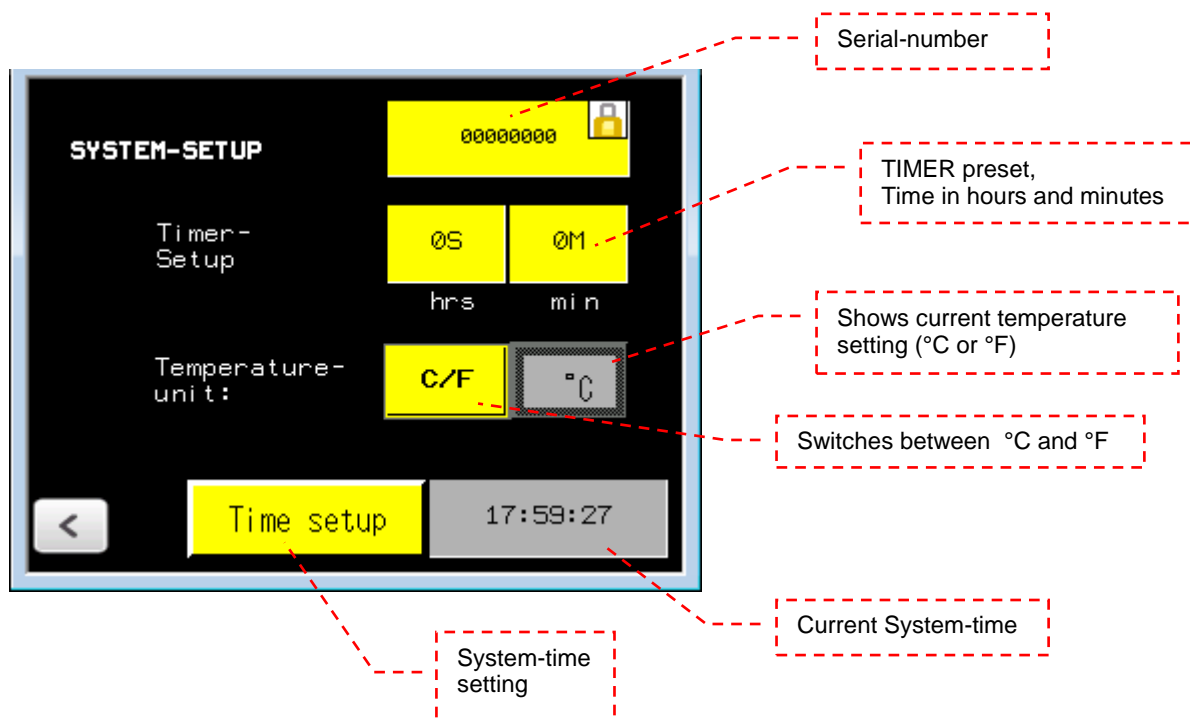



### 2.3.1.4. Heating process trend

The TREND screen gives an overview of the current heating process. Shown at the display is a graph of the MATERIAL-TEMPERATURE. The timeline can be scrolled by use of the BACK and FORWARD buttons. The END button jumps to the current time.

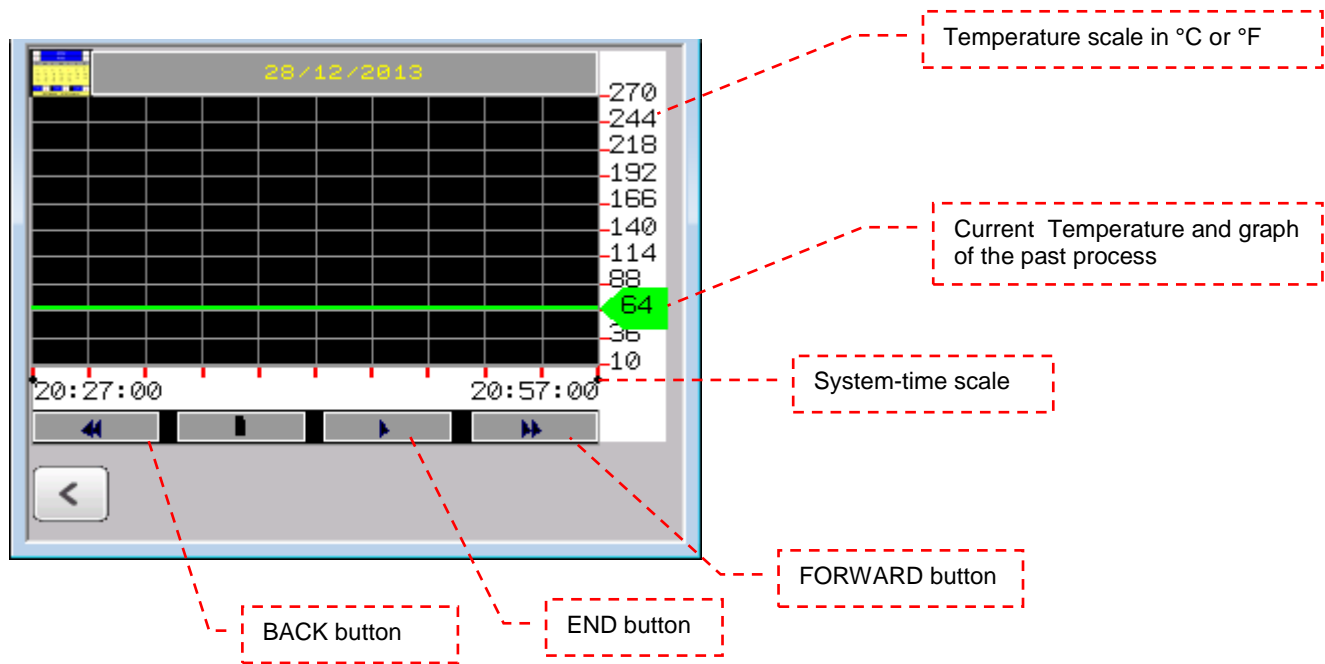

### 2.3.1.5. Errors

The error log stores disturbances and errors since the last turn on. An error could be a temperature sensor which does not work properly.



Zeit	Meldung	Ber
16:07:25	Modell Fühler nich	
16:07:51	Modell Fühler nich	

Error messages in chronological order

### 2.3.1.6. Ramp-setup

The ramp setup menu provides programming and activation options to allow a slowly heating with a raising heating ramp. The IR2102 DUAL offers the capability of saving different Temperature-profiles.

The ramp setup screen shows a conventionalized heating graph which is partitioned in to five segments. The user can individually adjust the temperature and time for each segment. Further an alarm can be set which is activated as soon as the end of the particular segment is reached (visual alarm at the screen and by blinking yellow tower light plus audible alarm). The user can confirm an activated alarm at the screen. During an active alarm the heating process runs regularly.

The screenshot shows the Ramp Setup interface with a heating graph divided into five segments. A red line represents the temperature profile, and a yellow tag is visible on the first segment. A blue button labeled 'Ramp OFF' is in the center. At the bottom, there are buttons for 'Remaining Process time', 'OH', and 'OM'. A question mark icon is also present.

- Add Temperature-Profile**: Callout for the 'NEW' button.
- Delete existing Temp.-Profile**: Callout for the delete icon.
- Select Temperature-Profile**: Callout for the dropdown menu.
- Load Temperature-Profile**: Callout for the load icon.
- Write input values to Temperature-Profile**: Callout for the edit icon.
- Save Temperature-Profile**: Callout for the save icon.
- Switch to set Ramp-feature ON/OFF**: Callout for the 'Ramp OFF' button.
- Tag of the segments 1-5. As soon as a segment tag is activated (yellow tag), the particular input mask is shown at the upper left corner.**: Callout for the yellow tag.
- Online Help**: Callout for the question mark icon.
- Input mask for segments 1-5**: Callout for the input fields showing '0°C # 1' and '0m' with an alarm icon.
- Remaining Process time**: Callout for the 'Remaining Process time' button.
- OH**: Callout for the 'OH' button.
- OM**: Callout for the 'OM' button.

**Additional notes:**

- When „RAMP ON“ is activated the total time of the heating process is displayed.
- As soon as the heating process is started, the remaining cycle time of the heating process is displayed

An online help is available for further explanation of the buttons. Pressing the (?) button will open a screen where detailed information for each button of the ramp-feature can be found.

The online help screen lists the following functions:

- Load Temperature-Profile**: Load Temperature-Profile
- Write new values to Temperature-Profile**: Write new values to Temperature-Profile
- Save Temperature-Profile**: Save Temperature-Profile
- Delete Temperature-Profile**: Delete Temperature-Profile
- Sets Alarm which will be activated as soon as Segment is reached**: Sets Alarm which will be activated as soon as Segment is reached

At the bottom, there is a button labeled **Rampe AUS** with the text **Turn ON/OFF Ramp Feature**.

To use a heating ramp a temperature-profile must be selected from the list and loaded into the controller by use of button (A).

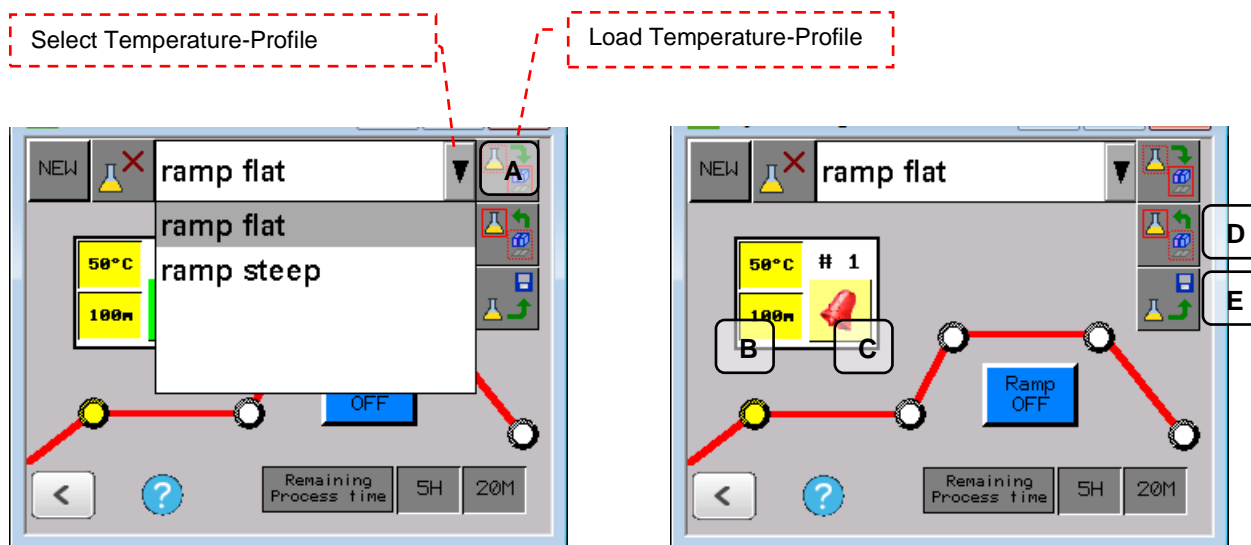

The stored values of segment 1 (yellow tap at red heating graph) will now be shown at the input mask (B). To show values of segment 2-5 the particular tap has to be activated. The values of the input mask will change to the activated segment.

Beside the temperature which shall be reached at the END of the segment the input mask allows to enter the time value the segment shall last. Further an Alarm can be set by use of button (C). An activated alarm (button is highlighted in green) will cause a visual alarm at the screen when the end of the segment is reached. The user can reset the alarm at the screen. (IMPORTANT NOTE: During an active Alarm the heating process will NOT be stop but normally proceed. The alarm is designed to remind the user of a potential intervention at this point of the heating process.

IMPORTANT NOTE! As soon as values have been changed at the input mask these need to be written back and stored at the Temperature-Profile first! To write back the values, button (D) has to be pressed and then stored by use of button (E). Otherwise the changed values will be lost and will not take effect at the current heating process!

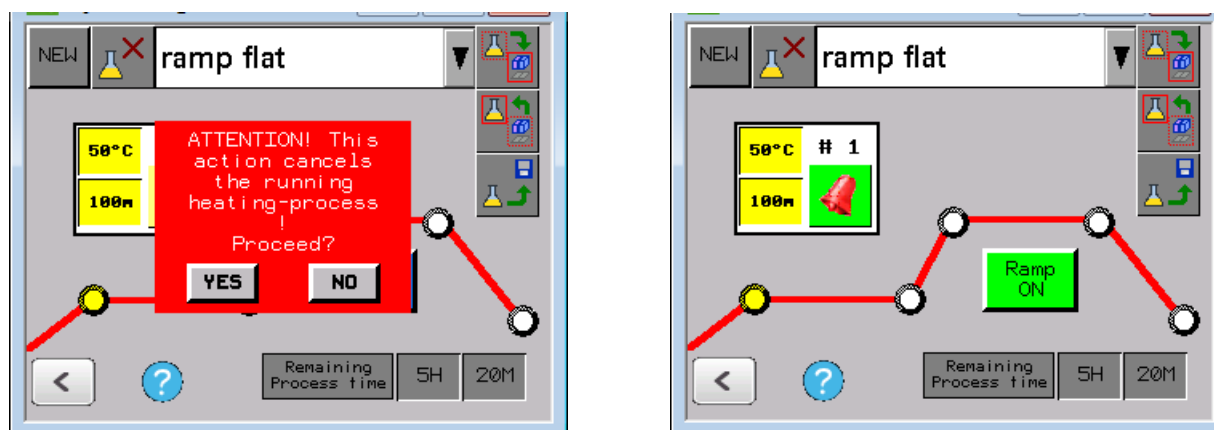

Finally button (F) need to be pressed to activate the Ramp-feature. After passing a reminder note the ramp-feature is activated and button (F) will change color from blue to green.

The ramp-feature status is also displayed at the main screen at the upper right corner.

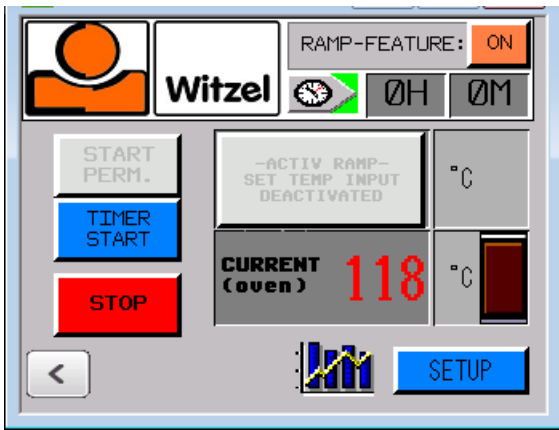

As soon as the ramp feature is activated the button for permanent oven operation as well as the set temperature input are deactivated. Both parameter are controlled by the ramp-feature resp. the Temperature-Profile of the heating-process.

With activated ramp-feature also the timer value will be overwritten. The active ramp-feature always calculates the total time by adding segments 1-5 of the activated Temperature-Profile.

### 2.3.1.6.1. Adding additional ramps:

Additional ramps can be set up by the user as follows:

- 1) Select „NEW“ button
- 2) Selecting the new entry at the Temperature-Profile list will open the text keypad and the user can enter an individual name for the new Temperature-Profile. Pressing „ENTER“ will close the keypad again.
- 3) Next the nominal values of segment 1 to 5 are entered for the Temperature –Profile.
- 4) **IMPORTANT! When finished, the new Temperature Profile written back by pushing button (D) and then saved by button (E). Otherwise the data that were entered are lost in the next step.**
- 5) Now another ramp can be created in the same way, or the ramp that has just been set up can be started (see above).

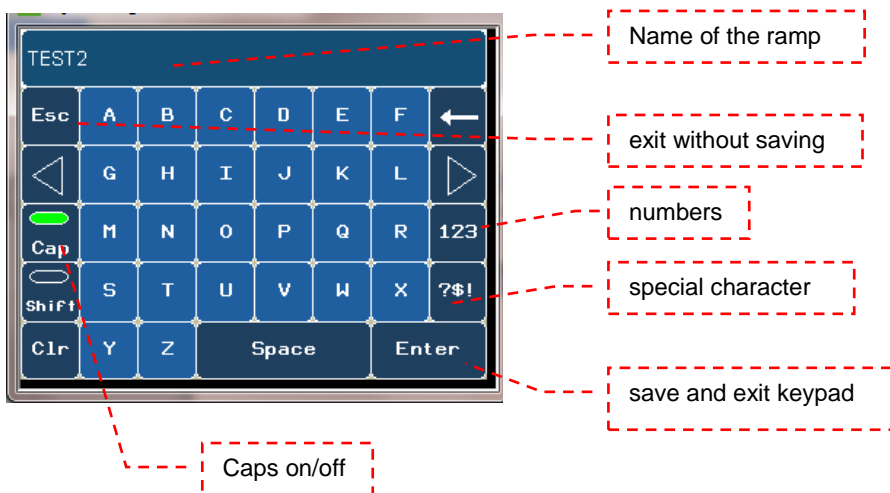

### 2.3.1.6.2. Renaming a ramp:

The names of the ramps that have been set up can be changed individually by the user as follows:

- 1) Select the Temperature-Profile to be changed from the list.
- 2) Tapping the name displayed opens the text keypad where the user can change the name of the Temperature-Profile. Select "ENTER" to close the text input screen when finished.
- 3) **IMPORTANT! When finished, the new Temperature-Profile to be saved by use of button (E). Otherwise the data that were entered are lost in the next step.**

### 2.3.1.7. PID-Setup- und System-Login

The temperature setting parameters are administered in the PID setup menu. To ensure proper functioning of the oven, these parameters must not be modified without instruction. Therefore they are protected against unintentional changes by a system login.

The login data are provided by technical customer service when they are required.

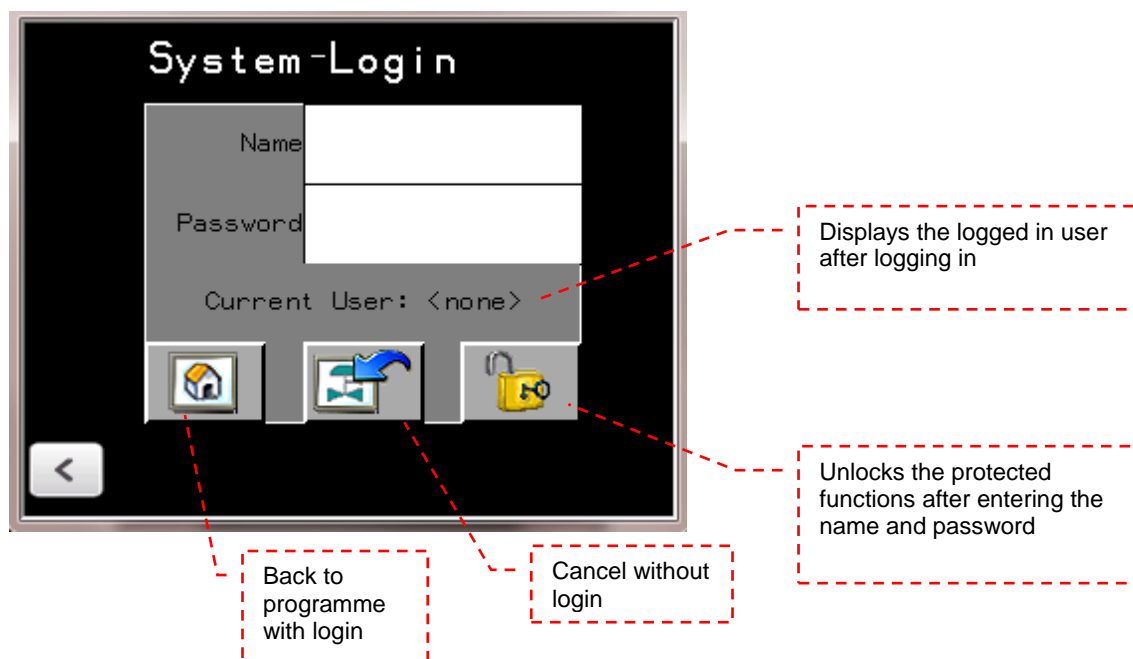

When the system is shut down the user that is currently logged in is automatically logged out again.

## 2.3.2. Managing the oven

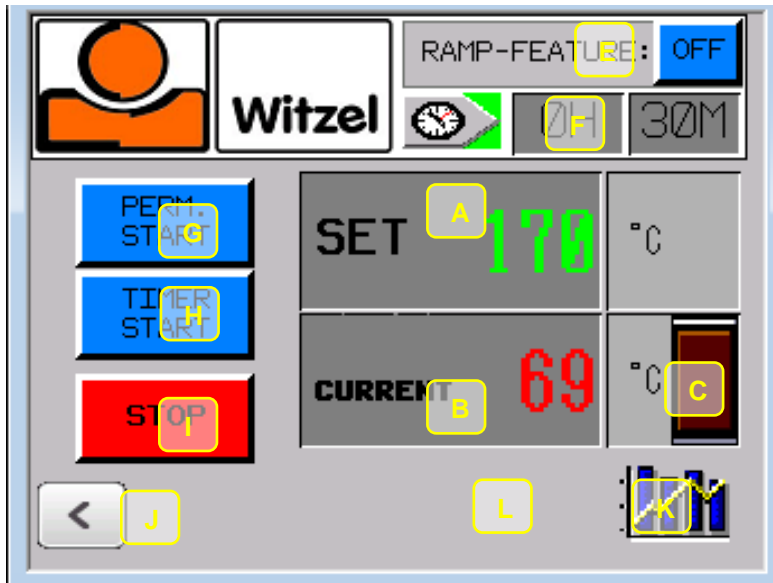

- A - SET                      Setting the nominal temperature. Tap the green number to set.  
NOTE: With an active heating ramp the SET temperature input is locked as the temperature control is handled by the heating ramp during this operation mode.
- C - CURRENT                Display of the oven temperature (an optical sensor measures the surface temperature of the material (marking at the table) active in operating mode “Control via oven temperature”)
- D - LED red                Lights up/flashes when oven heating is active
- E - Ramp Function        This button opens the “Ramp Setup” menu screen. For more information about setup and activation, see 2.3.1.6. In addition, the blue LED indicates the current status “ON” or “OFF” for the ramp function.
- F - TIMER                    This button opens the system menu screen. Here the time for the timer function can be preset in hours and minutes. For more information, see 2.3.1.3. The preset time is displayed next to the timer button. When timer operation has been started with the “H” button, the remaining time is displayed.
- G - START PERMANENT    This button starts the oven in continuous operating mode. During active operation, the color of the button changes from blue to light green. Note: When the ramp function is active, this button has no function since the ramp function can only be used in timer operating mode. When exiting the operating mode using the “J” button during active operation, the warning “ATTENTION! This action cancels the current heating process! Continue?” is displayed. The option “YES” stops the heating process and returns to the start screen. If “NO” is selected, the heating process keeps running.
- H - START TIMER            This button starts the oven in timer operating mode. During active operation, the color of the button changes from blue to light green. When exiting the operating mode using the “J” button during active operation, the warning “ATTENTION! This action cancels the current heating process! Continue?” is displayed. The option “YES” stops the heating process and returns to the start screen. If “NO” is selected, the heating process keeps running.
- I - STOP                     This button stops operation of the oven in any operating mode.
- J - "<"                        This button closes the current screen, returning to the previous screen (applicable to all screens).
- K - PROCESS                This button opens the process screen. An overview of the current heating process is displayed in the process screen. For more information, see 2.3.1.4.





### 2.3.3. Error- and Alert-Messages

Possible Error- and Alert-Messages of the system are listed below.

#### 2.3.3.1. Open door

This message shows up as soon as the door is opened during a running heating process. As it can happen that the door is opened intentionally during a running heating process, this process is NOT stopped by the open door. Nevertheless the Infrared heating is deactivated automatically as long as the door is opened. After the door has been closed again, the heating process is continued regularly.

#### 2.3.3.2. Termination of the heating process

As soon as the "<" button is tapped, the ramp feature is tried to turn ON or OFF or the temperature setting (°C/°F) is tried to switch, a message is shown up that the intended feature will terminate the current heating process. The message can be confirmed by tapping "YES" or the user can return to the current heating process without changes leaving the message with "NO".

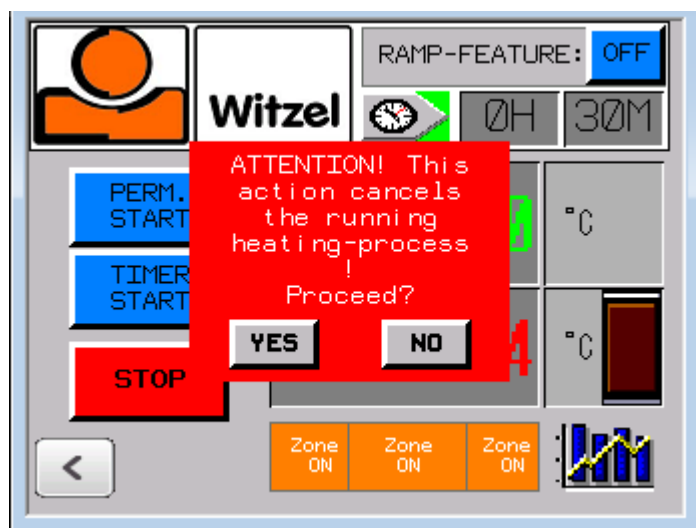

### 3. Application of the IR2102 DUAL

#### 3.1 General notes

The infrared oven IR2102 DUAL can be used to heat all thermoplastic materials which are on the market. Concerning the process instructions, especially the process temperature please follow the advisory message of the manufacturer. Best results can only be achieved when the recommended temperature is observed.

Caused by the working method and the used components **no pre-heating** of the IR2102 DUAL is necessary (others than convection ovens). The system works with infrared radiant heat and has 100% effect already a few moments after it is turned on. Further the IR2102 DUAL can be directly switched off when not needed. This can also be done by use of the DUAL Zone switches, separately for the left and right Zone. If you use the IR2102 DUAL - as intended at its development - only when needed, you save a lot of energy and save the ovens components! NOTE: As long as the door is opened the IR-tubes are automatically shut off.

#### 3.1.1 Special notes for the DUAL version

To extend the application field of the IR2102 it has been designed as a DUAL version. It is equipped with two full-value controller and separately working thermostats (optical feeler). Thus the left and the right Zone can be used independently with different temperatures at the same time (e.G. PE at 165°C on the left side and PP at 205°C on the right side). On the other hand large sheets of 2x1 meter can be heated as well. To do so just setup both Zone at the same temperature. Thus both Zones act as one. On the other hand, when just one Zone is needed, the other can simply be shut down by use of the respective DUAL Zone Switch.

To ensure the most even heating result at each Zone a separating wall is installed (hanging) in the middle of the oven. The wall reflects the IR-rays of the respective Zone and separates it from potential Temperature differences of the other Zone. Normally the wall can stay installed even when heating large sheets on both Zones. Should the wall be disassembled, it can easily be removed without any tools **FROM THE COLD OVEN**.



**ATTENTION! HOT MATERIALS AND/OR HIT SURFACES!  
DANGER OF BURNING! ALWAYS WEAR HEAT-PROTECTION-GLOVES!**

The following instructions refer to a single Zone and can be transferred without any restrictions to the second Zone resp. to the simultaneous use of both.

**IMPORTANT NOTE: Please note that at the oven can just heat flat materials OR Blister-forming trays AT THE SAME TIME. Due to the necessary height adjustment of the tray which is unconditionally important for an even heating result, a combination of both is not possible.**

### 3.2. Heating of flat plastics directly on the tray

- The IR2102 is turned on by use of the ON-OFF main switch (pic. 11 (A)). After the Start screen shows up the operation mode is selected by pushing the START button
- by pushing the green SET temperature it can be adjusted to material to be heated. The number will be set by pushing the ENTER button at the keypad.

ATTENTION! To get the best heating results the temperature recommended by the manufacturer should be selected! Selecting a higher temperature does **NOT** heat the material faster but overheats and burns the material and destroys the material most times!



ATTENTION! DANGER OF SELF-IGNITION  
OF OVERHEATED MATERIAL!

- The door of the oven is opened by turning the door handle and pulling it upright.
- The Roll about tray can be pulled out of the oven using the handle under the tray.
- To heat flat plastics directly at the tray, the tray needs to be set to its upper position. To do this the lever behind the handle of the Roll about tray is pulled and hold and the tray is lifted. When the tray is set to the required position, the lever can be released and the tray will be locked at its new height.
- Now the material is put at the tray. **When using smaller pieces of material it is necessary to put those right into the middle of the marked measuring area at the tray!** Only thus a correct determination of the materials surface temperature is ensured!
- The Roll about tray is pushed completely into the oven again and the front-door is closed by pushing it down until it locks at its end position.
- The heating process will be started by pushing the PERM START button - or if desired by pushing the TIMER START button.
- Now the heating process can be observed at the front-door's viewing window or the CURRENT temperature displayed at the Touch-panel.



ATTENTION! HOT MATERIALS AND/OR HIT SURFACES!  
DANGER OF BURNING! ALWAYS WEAR HEAT-PROTECTION-GLOVES!

- After reaching the desired (selected) temperature the IR2102 keeps this constant by a pulsed switching of the infrared-tubes. As soon as the material is heated through (**might take some minutes with thicker materials**), it can be taken out of the oven. For this the door is opened as described above and the Roll about tray shall be pulled out of the oven as far as the material can be easily picked up. With larger pieces of material (e.g. larger orthotics or body jackets) it can be helpful to move the Roll about tray to the workplace and pick up the material just there. NOTE: As soon as the oven door is opened, the IR-tubes are deactivated automatically to save energy.

Should the oven not be in use at this time any more, turn it off in the meantime, resp. deactivate the infrared tubes by pushing the STOP button. As the infrared system doesn't require any pre-heating a lot of energy can be saved this way.

### 3.3. Heating of plastics with a Blister-Forming frame

- The IR2102 is turned on by use of the ON-OFF main switch (pic. 11 (A)). After the Start screen shows up the operation mode is selected by pushing the START button
- by pushing the green SET temperature it can be adjusted to material to be heated. The number will be set by pushing the ENTER button at the keypad.

ATTENTION! To get the best heating results the temperature recommended by the manufacturer should be selected! Selecting a higher temperature does **NOT** heat the material faster but overheats and burns the material and destroys the material most times!



ATTENTION! DANGER OF SELF-IGNITION  
OF OVERHEATED MATERIAL!

- The door of the oven is opened by turning the door handle and pulling it upright.
- The Roll about tray can be pulled out of the oven using the handle under the tray.
- To heat blister forming trays, the Roll about tray needs to be set to its lowest position. To do this the lever behind the handle of the Roll about tray is pulled and hold and the tray is pushed down. When the tray is set to the required position, the lever can be released and the tray will be locked at its new height.
- Now the blister forming frame (with own legs) or the cradle (option, Article 07-131) for blister-forming frames is placed at the center of the roll about tray. Next the blister-forming frame with the clamped in material is placed at the cradle and aligned right under the center pair of IR-tubes. **It must be ensured that the optical sensor still measures the outer part of the material and NOT the blister-forming frame (Diameter of the measuring spot is approx. 4" at this distance)!** Only thus a correct determination of the materials surface temperature is ensured! **IMPORTANT! It has also to be ensured that the material is never put higher than the level of the upper circumference edge inside of the oven! Placing the material closer to the IR-tubes will cause an uneven heating result in any way! (See additional notes enclosed). When using third party blister forming frames it might be necessary to adjust the length of existing legs.**

- The Roll about tray is pushed completely into the oven again and the front-door is closed by pushing it down until it locks at its end position.
- The heating process will be started by pushing the PERM START button - or if desired by pushing the TIMER START button.
- Now the heating process can be observed at the front-door's viewing window or the CURRENT temperature displayed at the Touch-panel.



ATTENTION! HOT MATERIALS AND/OR HIT SURFACES!  
DANGER OF BURNING! ALWAYS WEAR HEAT-PROTECTION-GLOVES!

- After reaching the desired (selected) temperature the IR2102 keeps this constant by a pulsed switching of the infrared-tubes. As soon as the material is heated through (**might take some minutes with thicker materials**) and sagged sufficiently it can be taken out of the oven. For this the door is opened as described above and the Roll about tray shall be pulled out of the oven as far as the blister forming frame can be easily picked up. NOTE: As soon as the oven door is opened, the IR-tubes are deactivated automatically to save energy.

Should the oven not be in use at this time any more, turn it off in the meantime, resp. deactivate the infrared tubes by pushing the STOP button. As the infrared system doesn't require any pre-heating a lot of energy can be saved this way.

### 3.4. Specials

The tray of your IR2102 DUAL infrared oven is equipped with a nonstick Teflon coating. When necessary you additionally can prevent the heated materials from sticking by use of some talc (powder).

## 4. Care and maintenance

### 4.1. Oven housing

The housing of the IR2102 DUAL oven is maintenance-free. You should regularly clean the housing inside and outside with a soft cloth from dust.

### 4.2. Front-door

The ball-bearing-guides on both sides of the front-door should be cleaned from dust with compressed air regularly. Once a year the ball-bearing-guides should be greased with oil or lubricant (The easiest way to do so, is to put some oil at the top of the ball bearing guides, so it can run down the bars and the ball bearings inside.) **ATTENTION! In case of a malfunction (loss of pressure etc.) the gas-shock has to be replaced completely. Never try to repair a gas-shock by yourself. Gas-shock have a very high inner pressure. Opening or manipulation of gas-shocks can lead to serious injuries!**

### 4.3. Quartz-Infrared-Tubes

The 28 quartz-infrared-tubes of the IR2102 DUAL are mounted on top of the oven. To guarantee a long lasting lifetime you only should turn them on when the oven is really used (pre-heating of the oven is not necessary and gives you no advantage to heat your materials) The (**cooled**) tubes can be cleaned from dust with a soft and dry cloth.

Quartz-infrared tubes have a wear out. Thus the heating capacity of the tubes can decrease after a few years of application. The tubes can be replaced single as described below. As there are also workings at the electricity, only authorized electricians are allowed to do this.

**-First unplug the power cord of the oven and be sure that the unit will stay unplugged while you are working on it. The oven has to be cooled completely for the workings.**

-Remove the screws M6 on top of the ovens cover (pic. 15).



pic. 15

pic. 16



-Now lift the cover at the front side and support it with a suitable object (lath 30cm (12") long) (pic. 16).

-The quartz-infrared tubes will be replaced completely with their aluminum housing (reflector). Each radiator (tube + housing) is mounted to the top of the oven housing with two sleeves M5 and has two connecting cables. (pic. 17).

pic. 17

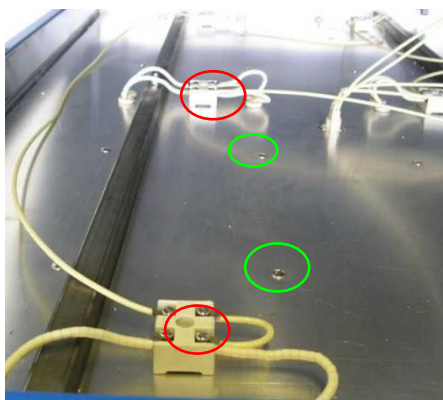

- Identify the radiator which you want to replace and loosen the two associated connection cables (red circle) at the respective connecting terminal.
- Now loosen the two screws M5 (green circle) of the respective radiator and pull it out of the housing to the underside.
- Next you can mount the new radiator by sliding the sleeves into the drill holes of the oven from the underside again. Pay attention to slide the two connection cables into the ceramic guides also and don't damage the ceramic insulation of the connection cables. The springs on the sleeves should rest against the underside of the upper aluminum plate of the heating area.
- Now fix the new radiator with the two sleeve nuts M5 again and tighten them.
- Connect the two connection cables to the respective connecting terminal again. Pay attention that you connect possibly cables of other radiators to the same terminal!
- If you plan to replace more than one radiator follow the instructions above. However you should change the radiators one after another to avoid wiring mistakes.
- Finally you can close the oven cover and fix it with the screws. Pay attention that you don't squeeze the connection cables of the cooling fan, mounted in the cover.



#### 4.4. IR Optical measuring device

The optical measuring device is mounted between the radiators in the top of the oven (pic. 18). It is generally maintenance-free. However after a while dust and other soilings can cover the lens of the sensor and corrupt the measuring results. So a periodical cleaning (~every three month) helps to avoid malfunction. Clean the lens (coo oven) with a soft and cotton bud or a soft cloth. In case of stubborn soilings you can also use some water on the cloth.

pic. 18



#### 4.5. Illumination

The illumination consists of four special heat resistant 25watt bulbs. If one of the bulbs is defective you first have to remove the glass cover (cooled oven) of the bulb by hand. After this you can replace the bulb inside of the lamp by a new one. **ATTENTION!** Always use special heat resistant bulbs of the same type and the same capacity. The use of other bulbs can lead to malfunction of the bulbs or the oven!

#### 4.6. Roll about tray

The Roll about tray is maintenance-free. All moving parts are guided in plastic bearings and need no maintenance. **ATTENTION! In case of a malfunction (loss of pressure etc.) the gas-shock has to be replaced completely. Never try to repair a gas-shock by yourself. Gas-shock have a very high inner pressure. Opening or manipulation of gas-shocks can lead to serious injuries!**

#### 4.7. Teflon coating

The tray is equipped with a replaceable Teflon-coating. To guarantee a long lasting lifetime you should clean the Teflon coating regularly (once a week) with a soft and dry cloth from contamination of talc or plastic residues.

When the coating is damaged or contaminations can not removed any more the coating can be replaced by a new one. For this follow the instructions below:

- Lift the tray with two persons out of the carriage (tray is only threaded and not fixed any more).
- Turn the tray around and lay it on its upside on a large table or the like.
- On the underside are rods at three places located. On one side they are hinged at the Teflon coating, on the other side they are joined in the middle by tension springs (pic. 19). First take off the springs and dismantle the rods carefully.
- Now lift the tray (consisting of aluminum, insulation and heat resistant layer - without the Teflon coating) with two persons and set it aside. Pay attention that you don't displace the three layer of the tray and the insulation does not slip out (keep horizontal).
- Next replace the old Teflon coating by the new one and place the tray concentric on it.
- Hinge the rods into the edges of the new Teflon coating and tauten them with the tension springs.



- At the short sides the Teflon coating are simply wrapped around and maybe fixed with a little tape (only for easier handling and treading the tray).
- Finally you can put the newly covered tray into the carriage. Pay attention that the measuring area marking on the top is aligned to the front side of the carriage.

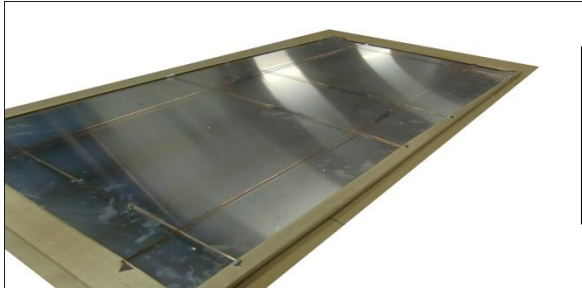

pic. 19  
pic. 19a

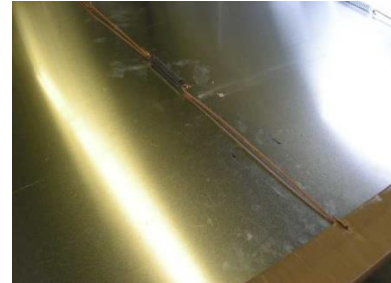

## 4.8. Breaker

The IR2102 DUAL is equipped with an automatic circuit breaker which trips in case of a short circuit or fault and shuts down the entire oven. Should the breaker be tripped it can be reset.

The breaker is located inside of the black switchbox. **First turn off the oven by use of the main switch and unplug the oven and ensure that the unit will stay unplugged while you are working on it.**

Open the switchbox by removing the 4 screws (2 on top + 2 on bottom) of the outer switchbox cover. After removing the cover, the breaker can be checked and reset if necessary. If the breaker should trip again, please contact our technical support.

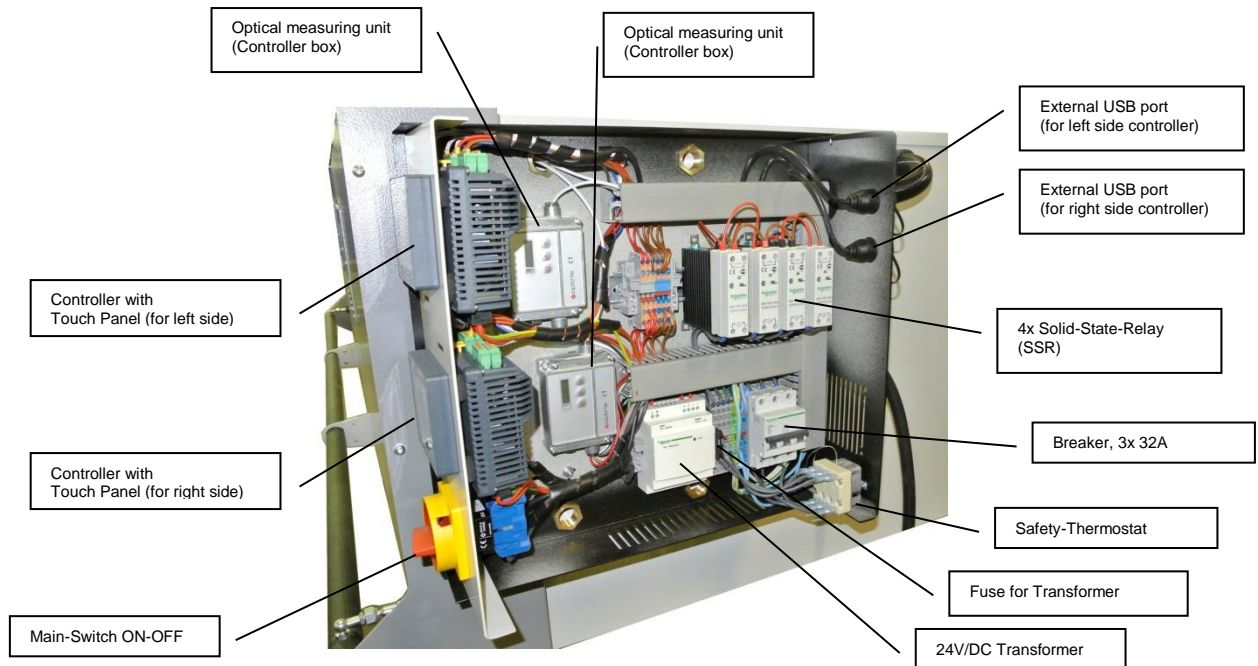

Pic. 20  
(Note: picture shows 3 phase version)

#### 4.8.2 Micro fuse

Beside the master breaker the oven is equipped with a 2A (time delay) fuse to protect the 24 VDC transformer. This fuse is located in a black fuse-holder to the right of the transformer. A defective fuse is visualized by a lighted orange LED on top of the fuse-holder.

**ATTENTION! First turn off the oven by use of the main switch and unplug the oven and ensure that the unit will stay unplugged while you are working on it.**

To replace the fuse the upper part of the fuse-holder needs to come off to the top. This part can be opened and the fuse can be replaced. The fuse may just be replaced by an identical one (230V / 2A / time delay).

#### 4.8.3 Safety-Thermostat

In case of a malfunction of the Temperature control system, the IR2102 is equipped with a safety-thermostat (STB) which shuts down the oven when overheated. In that case the oven is shut down completely. The STB is located at the backside of the black switch-box. After the STB has tripped, turn off the main-switch (A) and let the oven cool down. After the oven has cooled down, you can reset the STB by pushing the red button until you hear it locking. Should the STB trip again, please contact our technical service.

### 4.9 Error messages and Retification of defects

#### 4.9.1. ERROR MESSAGE

For error messages and warnings of the microprocessor control unit, see section 2.3.1.5..

#### 4.9.2. RECTIFICATION OF DEFECTS

The IR1302 Infrared oven is equipped with various fuses to protect the user, surroundings and certain of its components. Triggering the fuses can lead to the symptoms described below.



**DANGER**

Work on electrical equipment and components may only be completed by trained, qualified personnel or licensed electricians!

#### **A) The oven is entirely non-functional after switching it on:**

- 1) There is a problem with the power supply to the oven. For proper operation, all three phases as well as N and PE of the CEE outlet have to function correctly. Check the fuses on the building side if applicable. Contact customer service if the problem recurs.
- 2) The safety temperature limiter was triggered.  
In case of thermostat control malfunctions, the oven may overheat and trigger the safety temperature limiter. The cause of the thermostat control malfunction must be determined and eliminated. The oven has to be cooled to room temperature. Then the

safety temperature limiter on the back of the control unit box can be reset. Contact customer service if the problem recurs.

- 3) The main circuit breaker of the oven was tripped.

In case of a problem with the electrical system, the main circuit breaker (3x 16A circuit breaker) in the control unit box may be tripped. To reset the main circuit breaker, the exterior cover of the control unit box has to be removed. First switch off the oven and pull the mains plug. Then remove the upper and lower exterior screws on the control unit box cover. Once the circuit breaker has been reset, close the control unit box and reconnect the mains plug. Contact customer service if the problem recurs.

**B) After powering up, the interior lighting of the oven works, but the control unit is entirely non-functional:**

- 1) The micro-fuse of the 24VDC transformer has blown. To replace the micro-fuse, the exterior cover of the control unit box has to be removed. First switch off the oven and pull the mains plug. Then remove the upper and lower exterior screws on the control unit box cover. The micro-fuse is installed in a black plastic fuse holder next to the transformer. The upper half of the fuse holder is flipped up and then the side cover is opened. Replace it only with a micro-fuse of the same type (20x5mm, 230V / 2A). Once the fuse has been replaced, close the control unit box and reconnect the mains plug. Contact customer service if the problem recurs.

**C) The thermostat control of the oven is not operating correctly. The material is overheated even if the correct temperature is preset:**

- 1) The thermostat control of the oven is operating with an optical sensor. The sensor is equipped with a special glass lense. If this lense is dirty the optical sensor cannot measure the correct temperature of the material. For detailed instructions how to clean the lense and fix the problem refer to section 4.4.. Contact customer service if the problem recurs.



## 5. Circuit diagram IR2102 DUAL (208V / 50/60Hz / 1 phase)

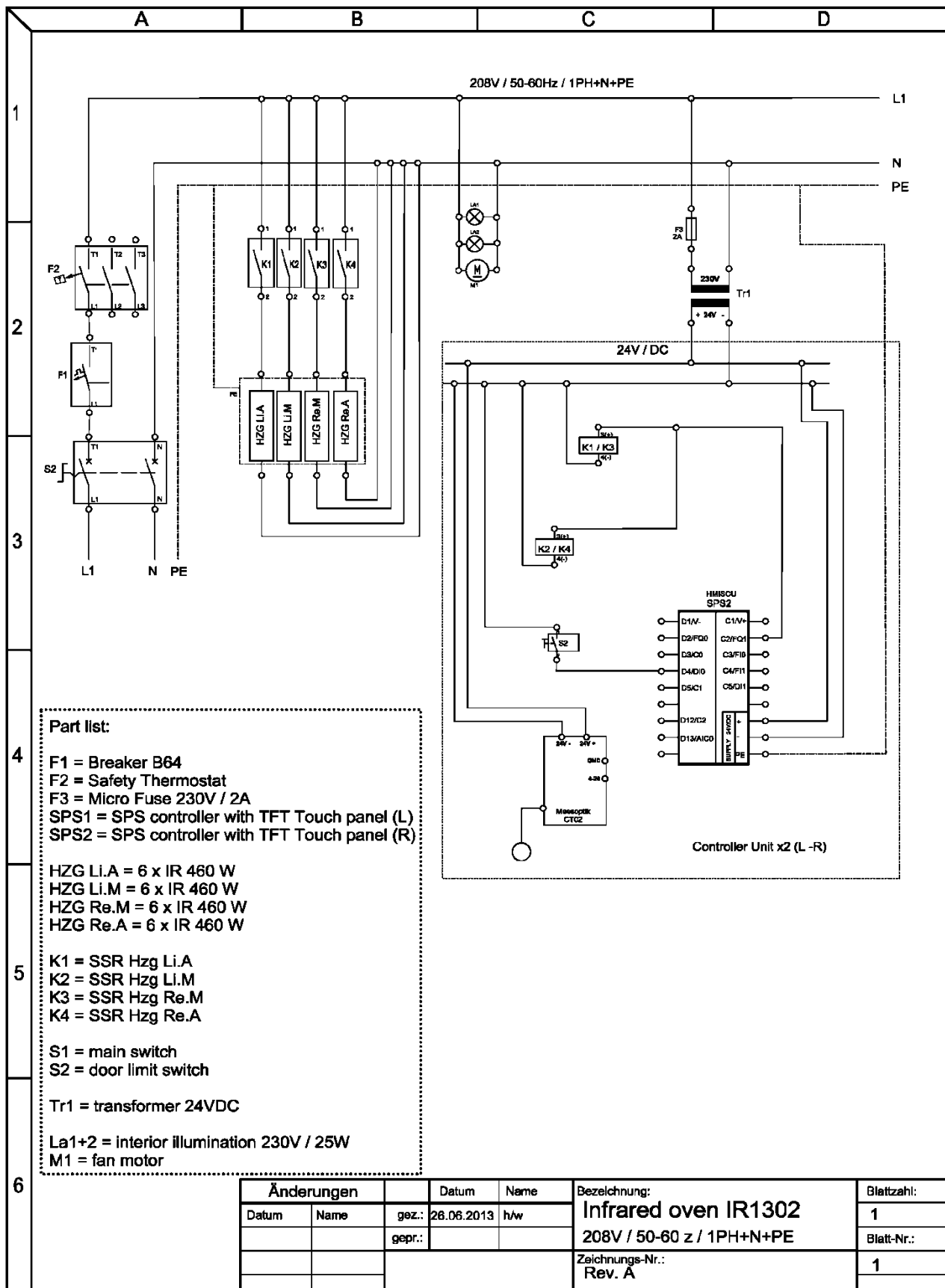

## 6. Spare parts IR2102 DUAL

<b>No.</b>	<b>Marking</b>
07-210-001	gas-shock door 265N (2 pc.)
07-210-002	gas-shock Roll about tray (lockable) (2 pc. )
07-210-003	Knob to part 07-130-002
07-210-004	Double pane viewing window (incl. Silicon sealing)
07-210-005	Silicon door sealing
07-210-006	Optical infrared temp. sensor with electronic box (2 pc. )
07-210-008	Infrared-tube 460W / 490 mm completely with reflector (28 pc.)
07-210-009	Teflon-coating for Roll about tray
07-210-010	lockable casters
07-210-011	Cooling fan for IR-Temperature sensor (2 pc. )
07-210-012/1	Automatic circuit breaker 3x32A
07-130-012/2	Micro fuse for transformer (2A / time delay)
07-130-013ST	SCHNEIDER Solid State Relay 20A1
07-210-014	Door guides (kit = 2 pc.)
07-130-018	SCHNEIDER Transformer 2,5A / 24V DC
07-210-019	Heating Selection switch CG6 A290-600 FS2 (2 pc. )
07-210-021	Main switch KH32
07-130-040	SPS Controller with Touch-panel 3,5"
07-130-040/F	Protection film for Touch-panel 3,5" (set of 5pc.)

## 7. Technical Details

Type:	Infrared-Oven IR2102 DUAL for the O&P field
Manufacturer:	Witzel VACUPRESS e.K. Max Keith Str. 66 – D-45136 Essen – Germany Tel. +49-201-6462-284 Fax +49-201-6462852
Height:	1300 mm
Width:	2545 mm
Depth:	1240 mm
Roll about ray:	2140 mm x 1030 mm (usable area BxT) Continuously height adjustable 710 mm – 940 mm
Footstep:	3,25 qm
Weight:	448 kg
Voltage:	208 V / 50/60 Hz / 1 Phase
Capacity:	12,9 kW
Heating:	28 Infrared-Quartz tubes with single reflector
Temperature-control:	opto-electrical by IR sensor (DUAL) Continuously 30-250°C (90-465°F), Electr. SPS Controller with 3,5" Touch panel Interface (2x)
Illumination:	4 x 25W bulbs



## 8. Declaration of Conformity

### Declaration of Conformity

for the Infrared-oven  
IR2102 DUAL (Art.Nr. 07-212D-400-3 / 07-212D-230-3 / 07-212D-2302102 DUAL-1)

**Witzel VACUPRESS e.K.**  
**Max Keith Str. 66 / D-45136 Essen**

declares as manufacturer and in sole responsibility that the Infrared-oven IR2102 DUAL complies with the fundamental requirements of the directive 2006/42/EG and the directives listed below - including all changes, valid at the time of declaration.

The following additional EU-directives have been applied:

2006/95/EG  
2004/108/EG

The following harmonised standards have been applied:

DIN EN ISO 12100-1, DIN EN ISO 14121-1  
DIN EN 60204-1, DIN EN 60335-1, DIN EN 60335-2-48  
DIN EN 55014-1, DIN EN 55014-2

Name and address of the person who is authorized to assort the technical documents: Hendrik Witzel

Witzel VACUPRESS e.K.  
Hendrik Witzel



Essen, 03.03.2014







VACUPRESS  
DOES  
MORE...